

Fiche produit

LC3

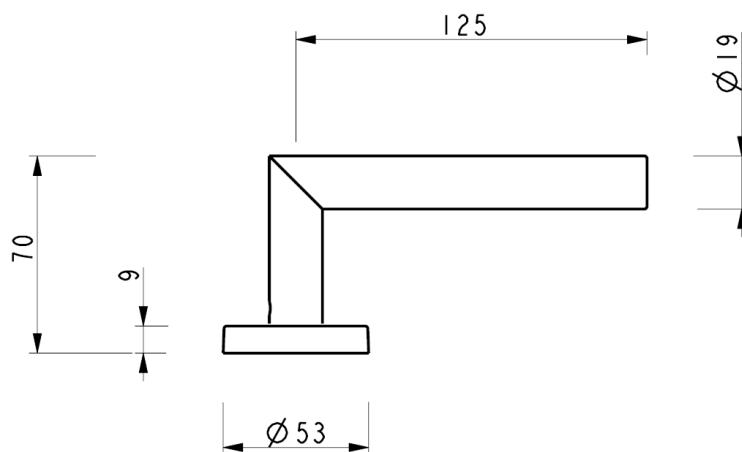









Gamme :

- Version béquille sur rosace
- Perçages :
 - Aveugle
 - Bec de cane
 - Clé I
 - Clé L
 - Condamnation simple
 - Condamnation à voyant
 - Protection cylindre
- Finition :
 - Inox brossé

Descriptif technique :

- Béquille en acier inoxydable AISI 202
- Ensemble monobloc : béquille et rosace solidarisées
- Ressort de rappel intégré
- Fixation invisible par vis traversantes entraxe 38mm
- Carré de 7mm
- Vis de fixation M4

Qualification selon la norme EN1906-2012

|  |  |  |  |  |  |  |  |
|--|---|---|---|---|---|---|---|
| Catégorie d'utilisation | Endurance | Masse de la porte | Résistance au feu | Sécurité des personnes | Résistance à la corrosion | Sécurité des biens | Type d'opération |
| 1 | 6 | -- | 0 | 1 | 4 | 0 | A |

Garantie
2 ans

ASSA ABLOY, the global leader in door opening solutions*

*ASSA ABLOY, le leader mondial des solutions d'ouverture de portes